

TAURUS



CZ – POZOR: Práce s výrobkem INNOTECH je povolena teprve po kompletním přečtení a porozumění bezpečnostních pokynů a návodu k montáži.

DE – ACHTUNG: Die Verwendung des INNOTECH-Produkts ist erst zulässig, nachdem die Sicherheitshinweise und Montageanleitung vollständig gelesen und verstanden wurden.

DK – GIV AGT: Det er først tilladt at anvende INNOTECH-produktet, efter du har læst og forstået sikkerhedshenvisningerne og monteringsvejledningen.

EN – ATTENTION: Use of the INNOTECH product is permitted only after the safety instructions and instruction manual in the respective language have been read.

ES – ATENCIÓN: Solo se autorizará el uso del producto INNOTECH una vez que se hayan leído y entendido completamente las indicaciones de seguridad y las instrucciones de montaje.

FR – ATTENTION : L'utilisation du produit INNOTECH n'est autorisée qu'après avoir intégralement lu et compris les consignes de sécurité et la notice de montage.

HU – FIGYELEM: Az INNOTECH termék használatát csak akkor engedhető meg, ha a biztonságági utasításokat és az összeszerelési utasításokat teljes mértékben elolvasta és megértette.

IT – ATTENZIONE: L'utilizzo del prodotto INNOTECH è permesso solo previa lettura completa e comprensione integrale delle avvertenze di sicurezza e le istruzioni di montaggio.

NL – ATTENTIE: Dit INNOTECH-product mag pas worden gebruikt nadat u de gebruikershandleiding en de montagehandleiding volledig heeft gelezen en begrepen.

PL – UWAGA: Używanie produktu INNOTECH jest dozwolone dopiero po zapoznaniu się z wszystkimi zasadami bezpieczeństwa i instrukcją montażu.

PT – ATENÇÃO: O uso do produto INNOTECH apenas é permitido depois de terem sido lidas e compreendidas na totalidade as indicações de segurança e o manual de montagem.

SK – POZOR: Použitie výrobku INNOTECH je povolené až vtedy, keď si úplne prečítate a pochopíte bezpečnostné pokyny a montážny návod.

SL – POZOR: Uporaba izdelkov INNOTECH je dovoljena šele po tem, ko preberete in so vam jasne vse varnostne opombe in navodila za montažo.

SV – O B S : INNOTECH-produkten får inte användas, förrän säkerhets- och monteringsinstruktionerna har lästs igenom och förstås fullständigt.

TR – DİKKAT: INNOTECH ürünü'nün kullanımına ancak güvenlik uyarılarını ve montaj talimatını tamamen okunup anlaşıldıktan sonra izin verilir.

ZH – 注意: 只有在完全阅读并理解安全提示和装配说明书之后,才允许使用INNOTECH产品。



1



2



3

4



36

3



24

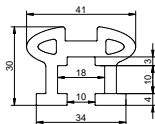

[mm]

**TAURUS-RAIL-10**

L 3000 : 6000

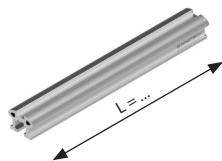
**HORIZONTAL | VERTICAL | ALLROUND****TAURUS-RAIL-20**

| α° | 15° | 30° | 45° | 60° | 75° | 90° |
|----------------|-----|-----|-----|-----|-----|-----|
| L | 480 | 552 | 614 | 666 | 707 | 735 |
| \pm | 320 | 320 | 320 | 320 | 320 | 320 |

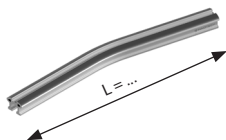
**HORIZONTAL | VERTICAL | ALLROUND**

2

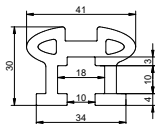

[mm]



TAURUS-RAIL-30

 $\angle x^\circ 90^\circ$ L 825 ± 0.385

VERTICAL ALLROUND

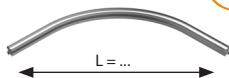

TAURUS-RAIL-40

 $\angle x^\circ 90^\circ$ L 829 ± 0.385



VERTICAL ALLROUND



TAURUS-RAIL-50

 $\angle x^\circ 90^\circ$ L 1700

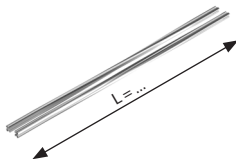
HORIZONTAL VERTICAL ALLROUND





TAURUS-BEND-10

 INNOTECH TAURUS-RAIL-20/-30/-40



AISI 304
AISI 316
STAINLESS
STEEL

HORIZONTAL **VERTICAL** **ALLROUND**



TAURUS-Z-91

 INNOTECH TAURUS 5m



AISI 304
AISI 316
STAINLESS
STEEL

HORIZONTAL

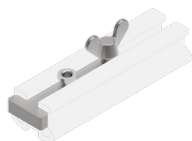

TAURUS-Z-92

 INNOTECH TAURUS-VB-11



AISI 304
AISI 316
STAINLESS
STEEL

HORIZONTAL **VERTICAL** **ALLROUND**



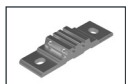

TAURUS-BEF-10



HORIZONTAL ALLROUND

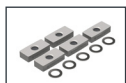
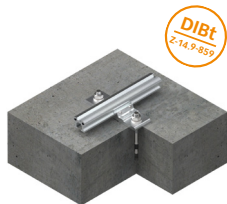

TAURUS-BEF-12



HORIZONTAL ALLROUND

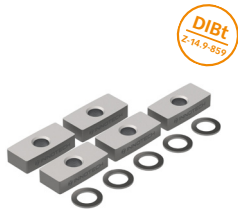

TAURUS-BEF-13



HORIZONTAL ALLROUND

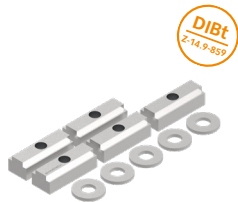



TAURUS-BEF-20



AISI 304
AISI 316
STAINLESS
STEEL



HORIZONTAL **ALLROUND**



TAURUS-BEF-21



AISI 304
AISI 316
STAINLESS
STEEL

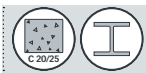

HORIZONTAL **ALLROUND**



TAURUS-BEF-30



AISI 304
AISI 316
STAINLESS
STEEL



HORIZONTAL **ALLROUND**





TAURUS-BEF-41



AISI 304
AISI 316
STAINLESS
STEEL



HORIZONTAL **ALLROUND**

DIBt
Z-14.9-859



TAURUS-BEF-50



AISI 304
AISI 316
STAINLESS
STEEL



HORIZONTAL **ALLROUND**



TAURUS-BEF-90



AISI 304
AISI 316
STAINLESS
STEEL



VERTICAL **ALLROUND**

DIBt
Z-14.9-859



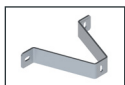

TAURUS-BEF-100

 INNOTECH TAURUS-STEP-10-....



VERTICAL **ALLROUND**

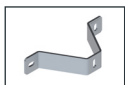

TAURUS-BEF-101

 INNOTECH TAURUS-STEP-20/-50



VERTICAL **ALLROUND**

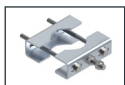

BEF-810/-811

 INNOTECH TAURUS-BEF-21/-30



TAURUS BEF-810

TAURUS BEF-811

HORIZONTAL **VERTICAL** **ALLROUND**



2



BEF-840/-841 + BEF-830-..

 INNOTECH TAURUS-BEF-21/-30



TAURUS BEF-840



TAURUS BEF-841



TAURUS BEF-830-..

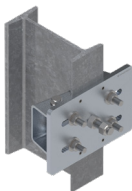

HORIZONTAL **VERTICAL** **ALLROUND**



TAURUS-EA-10



AISI 304
AISI 316
STAINLESS
STEEL

HORIZONTAL ALLROUND



TAURUS-EA-11



AISI 304
AISI 316
STAINLESS
STEEL

Al
ALUMINUM

HORIZONTAL VERTICAL ALLROUND

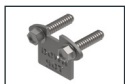
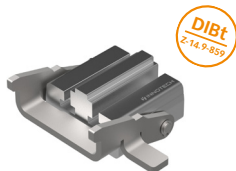

TAURUS-EA-21



AISI 304
AISI 316
STAINLESS
STEEL

VERTICAL





TAURUS-VB-10



HORIZONTAL **VERTICAL** **ALLROUND**



TAURUS-VB-11



HORIZONTAL **VERTICAL** **ALLROUND**

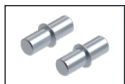

TAURUS-VB-12



HORIZONTAL **VERTICAL** **ALLROUND**

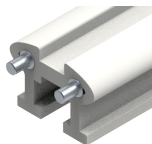

2



TAURUS-VB-13

 **INNOTECH TAURUS 5m**



AISI 304
AISI 316
STAINLESS
STEEL

HORIZONTAL



2



TAURUS-DW-10



AISI 304
AISI 316
STAINLESS
STEEL

AI
ALUMINUM

HORIZONTAL ALLROUND

DIBt
Z-14.9-859



2

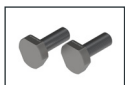

TAURUS-PS-H-11



INNOTECH TAURUS-GLEIT-H-11



AISI 304
AISI 316
STAINLESS
STEEL

HORIZONTAL VERTICAL ALLROUND



**TAURUS-SCE-10**

 INNOTECH TAURUS-SCE-50-A4



AISI 304
AISI 316
STAINLESS
STEEL

Al
ALUMINUM

PP, PVC,
...
PLASTIC

VERTICAL **ALLROUND**

**TAURUS-SCE-20**

 INNOTECH TAURUS-SCE-10



AISI 304
AISI 316
STAINLESS
STEEL

Al
ALUMINUM

VERTICAL **ALLROUND**

**TAURUS-SCE-50**

 INNOTECH TAURUS-SCE-10



AISI 304
AISI 316
STAINLESS
STEEL

PP, PVC,
...
PLASTIC

VERTICAL **ALLROUND**





[mm]

**TAURUS-STEP-10-....**

L 1425 | 1995 | 2850

INNOCENT TAURUS-BEF-100



TAURUS STEP-10-1425



TAURUS STEP-10-1995

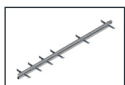
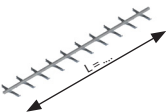
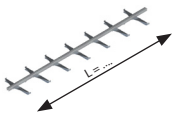
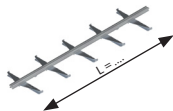

TAURUS STEP-10-2850

VERTICAL ALLROUND**TAURUS-STEP-20**

L 2395

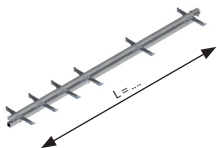
INNOCENT TAURUS-BEF-101
**VERTICAL
ALLROUND**

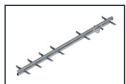

[mm]

**TAURUS-STEP-50****L** 2395

INNOTECH TAURUS-BEF-101

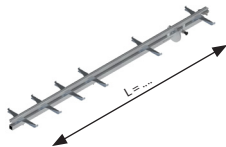
**VERTICAL****ALLROUND****TAURUS-SO-2019-10**

INNOTECH TAURUS-STEP-...-....

**VERTICAL** **ALLROUND**



[mm]

**TAURUS-AS-10****L** 2200

INNOTECH TAURUS-RAIL-10-....

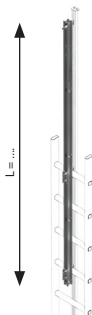

AISI 304
AISI 316
STAINLESS
STEEL

**VERTICAL** **ALLROUND****TAURUS-AS-20**

INNOTECH TAURUS-AS-10

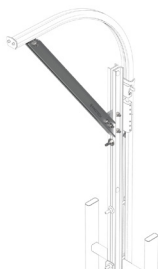

AISI 304
AISI 316
STAINLESS
STEEL

**VERTICAL** **ALLROUND**



[mm]

**TAURUS-GLEIT-H-11**
 $\angle x^\circ \pm 5^\circ$

 AISI 304
 AISI 316
 STAINLESS
 STEEL
HORIZONTAL
 DIBt
 Z-14.9-859
**TAURUS-GLEIT-V-21**
 $\angle x^\circ \rightarrow$

 AISI 304
 AISI 316
 STAINLESS
 STEEL
VERTICAL
 DIBt
 Z-14.9-859
**TAURUS-GLEIT-A-31**
 AISI 304
 AISI 316
 STAINLESS
 STEEL
HORIZONTAL VERTICAL ALLROUND
 DIBt
 Z-14.9-859



[mm]

**TAURUS-GLEIT-HO-50** $\angle x^\circ \pm 5^\circ$ 

AISI 304
AISI 316
STAINLESS
STEEL

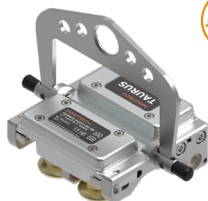
HORIZONTAL

DIBt
Z-14.9-859

TAURUS-EA-10 ✓

TAURUS-EA-11 ✗
**TAURUS-GLEIT-HO-51** $\angle x^\circ \pm 5^\circ$ 

AISI 304
AISI 316
STAINLESS
STEEL

HORIZONTAL

DIBt
Z-14.9-859

TAURUS-EA-10 ✓

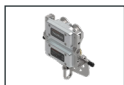
TAURUS-EA-11 ✗
**TAURUS-GLEIT-HO-52** $\angle x^\circ \pm 5^\circ$ 

AISI 304
AISI 316
STAINLESS
STEEL

HORIZONTAL
TAURUS-EA-10 ✓

TAURUS-EA-11 ✗



HORIZONTAL

EN 795 - TYP D

INNOTECH TAURUS

HORIZONTAL $0^\circ \pm 5^\circ$
 EN795:2012 TYP D
 DIN CEN/TS 16415:2017

INNOTECH TAURUS-GLEIT-H-11
 INNOTECH TAURUS-GLEIT-A-31
 INNOTECH TAURUS-GLEIT-HO-50
 INNOTECH TAURUS-GLEIT-HO-51
 INNOTECH TAURUS-GLEIT-HO-52
 INNOTECH TAURUS-GLEIT-S-111

№ | 10 m

14-07-10-TYP-795 D-Aufkleber-C

XXXX
 XXXX
 XXXX
 XXXX



HORIZONTAL

EN 795 - TYP D/E

INNOTECH TAURUS

HORIZONTAL $0^\circ \pm 5^\circ$
 EN795:2012 TYP D / E
 DIN CEN/TS 16415:2017

INNOTECH TAURUS-GLEIT-H-11
 INNOTECH TAURUS-GLEIT-A-31
 INNOTECH TAURUS-GLEIT-HO-50
 INNOTECH TAURUS-GLEIT-HO-51
 INNOTECH TAURUS-GLEIT-HO-52
 INNOTECH TAURUS-GLEIT-S-111

№ | 10 m

14-07-11-TYP-795 DE-Aufkleber-C

XXXX
 XXXX
 XXXX
 XXXX





VERTICAL

EN 353

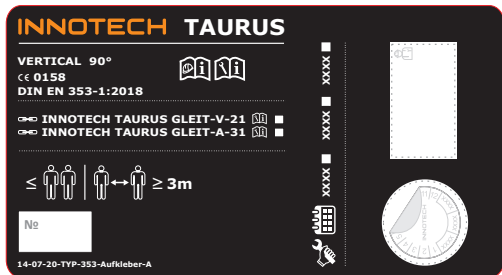

ALLROUND

EN 795 / EN 353

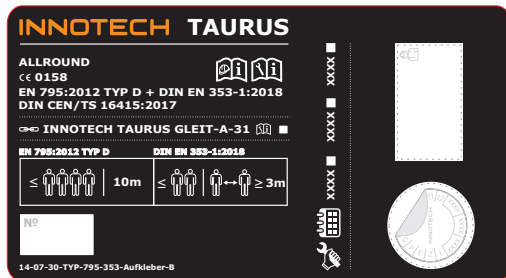



ALLROUND

DIBt

INNOTECH TAURUS

SCHIENENSYSTEM

- ☞ INNOTECH TAURUS-GLEIT-H-11 ■
- ☞ INNOTECH TAURUS-GLEIT-V-21 ■
- ☞ INNOTECH TAURUS-GLEIT-A-31 ■
- ☞ INNOTECH TAURUS-GLEIT-HO-50 ■
- ☞ INNOTECH TAURUS-GLEIT-HO-51 ■
- ☞ INNOTECH TAURUS-GLEIT-S-111 ■

HORIZONTAL **VERTICAL**

 | 3m

№

14-07-40-TYP-DIBt-Aufkleber-C

INNOTECH
Z-14.9-859
DEKRA

XXXX
XXXX
XXXX



ALLROUND

EN 795 / EN 353

INNOTECH TAURUS

☞ **INNOTECH TAURUS GLEIT-A-31**

DIN EN 353-1:2018 **EN 795:2012 TYP D**

 | 10m

14-07-35-TYP-Hinweis-Aufkleber-A



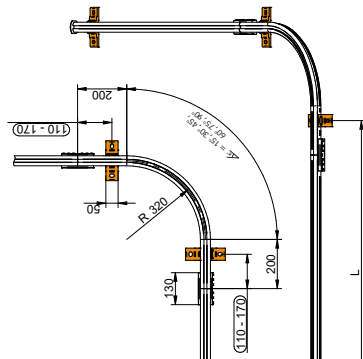
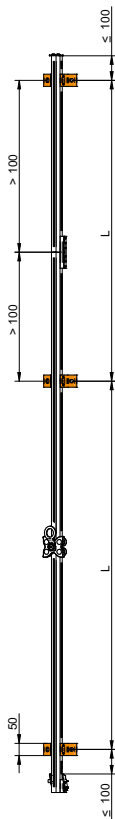

[mm]

HORIZONTAL**EN 795 - TYP D**

L HORIZONTAL ≤ 3000

L OVERHEAD = 1500
(≤ 3000)

L ABSEIL ≤ 1000

L =  BEF



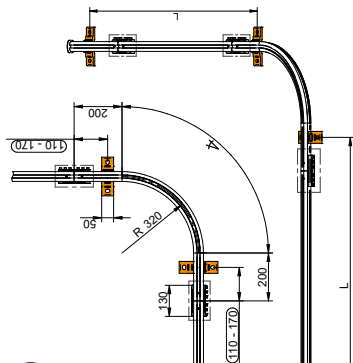
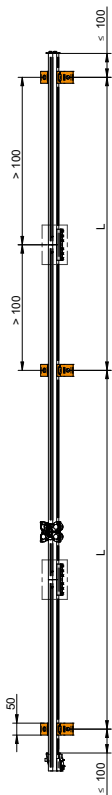

[mm]

HORIZONTAL**EN 795 - TYP D****TAURUS 5m**

BEF-10, BEF-13,
BEF-21, BEF-30

L HORIZONTAL = 3000-5000

L OVERHEAD = 3000-5000

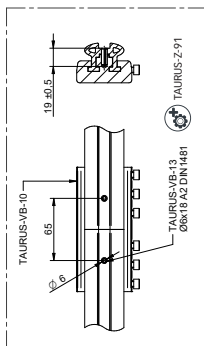

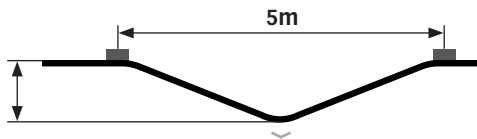
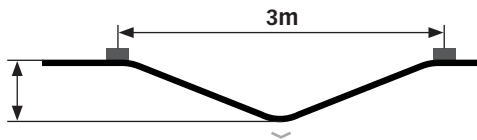
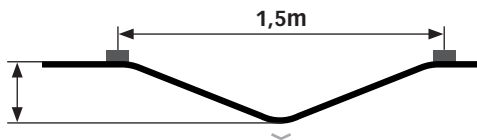
 $\leq 0,7\text{m}$  $\leq 0,4\text{m}$  $\leq 0,2\text{m}$ 

3

[mm]

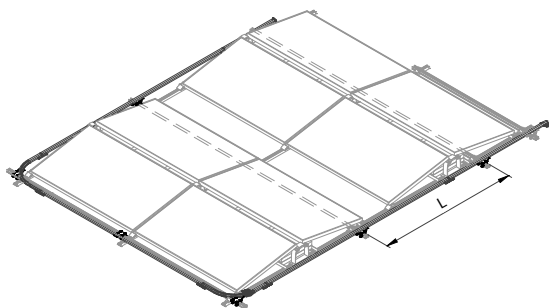
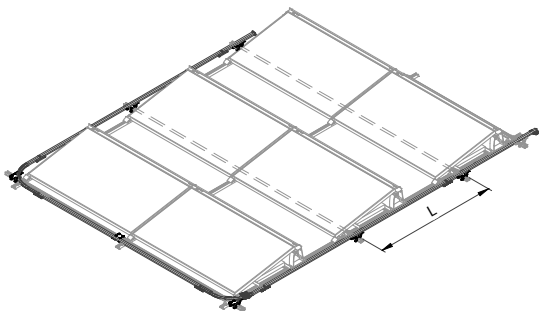
HORIZONTAL**EN 795 - TYP D/E****TAURUS-K2** $L_{\text{HORIZONTAL}} =$  **TAURUS-BEF-50**

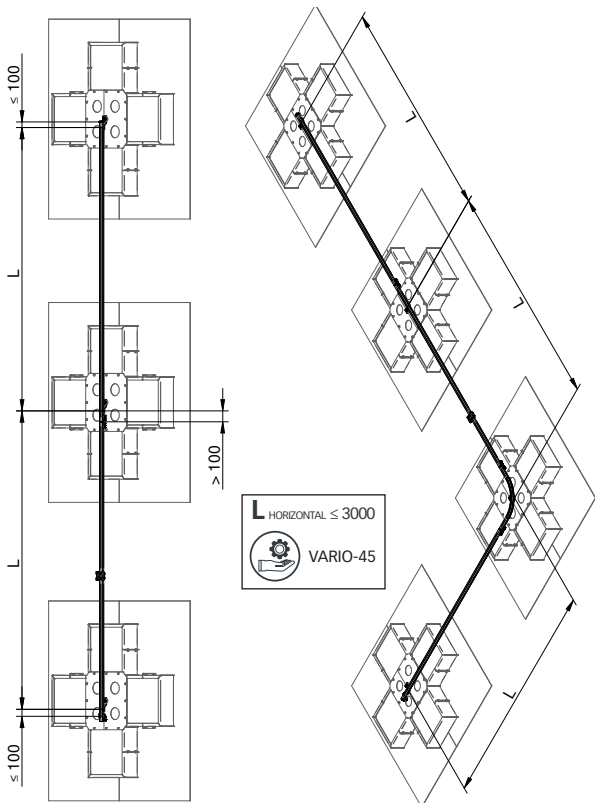

[mm]

HORIZONTAL**EN 795 - TYP D/E**



[mm]

HORIZONTAL

EN 795 - TYP D/E

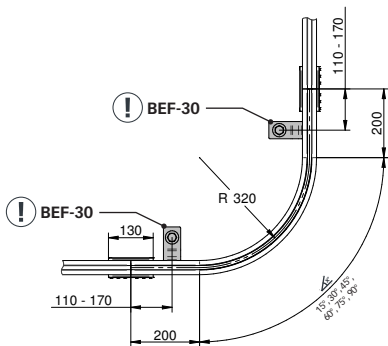
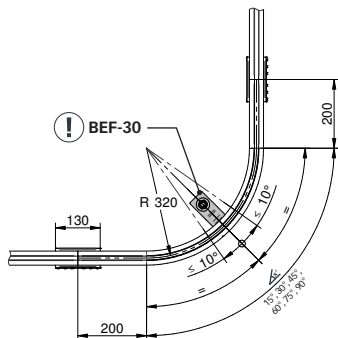



[mm]

VERTICAL

EN 353

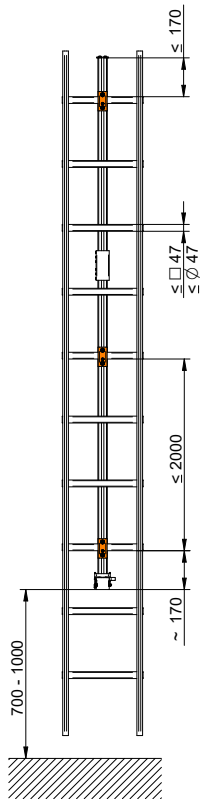
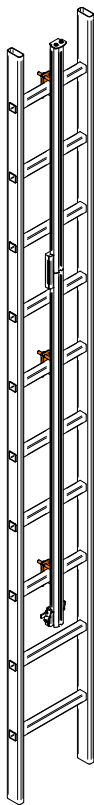



[mm]

ALLROUND

EN 795 / EN 353

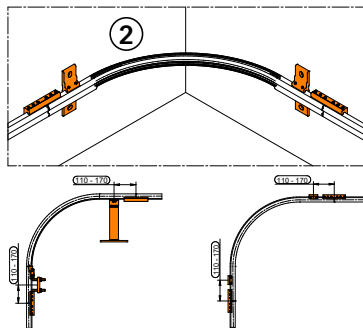
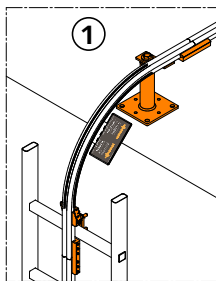
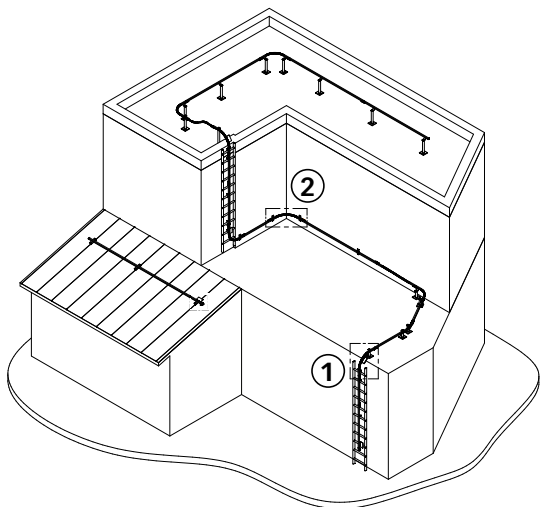

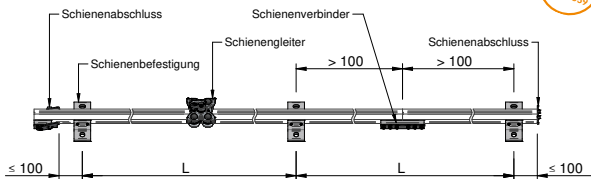

[mm]

HORIZONTAL**DIBt**

| | |
|----------|------------------------|
| L | HORIZONTAL ≤ 3000 |
| L | ABSEIL ≤ 1000 |

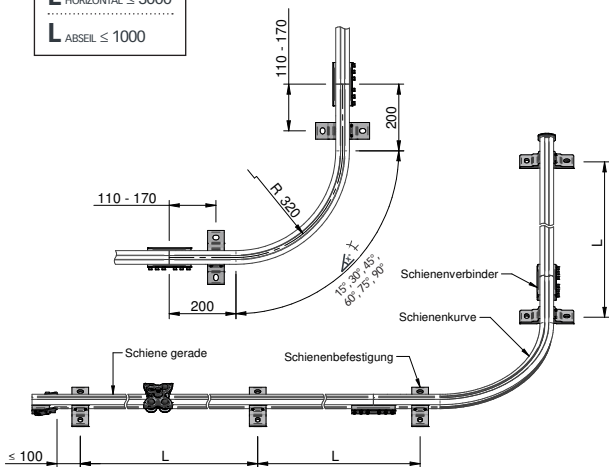



HORIZONTAL

DIBt

OVERHEAD

[mm]

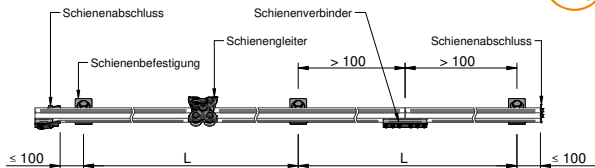
 $L_{\text{OVERHEAD}} \leq 3000$
 $L_{\text{ABSEIL}} \leq 1000$

BEF-30 + BEF-12

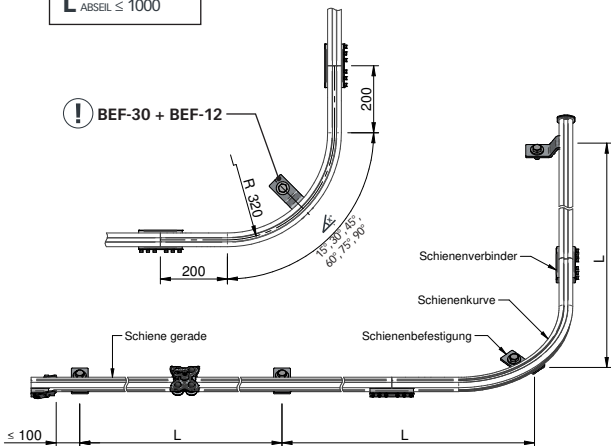



[mm]

VERTICAL

DIBt

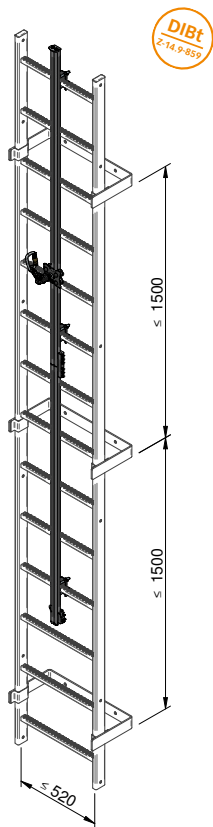
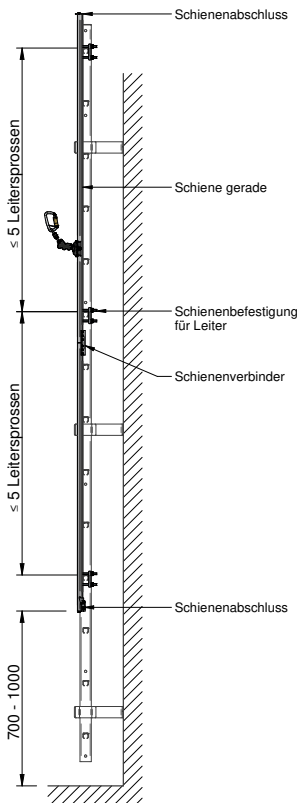



[mm]

VERTICAL

DIBt

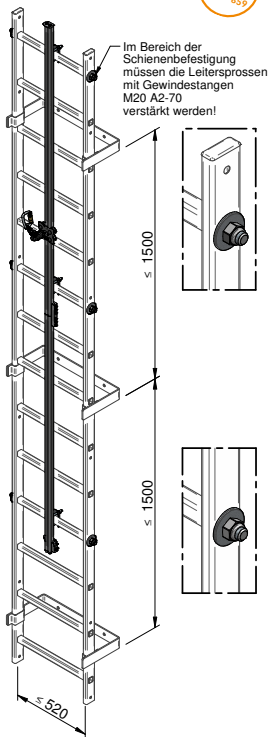
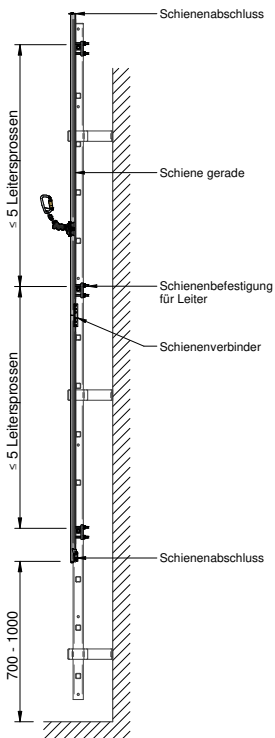

INNOTECH WEB-APP

INNO|doc

Simple. Clear. Document.



www.innotech.at/de/innodoc

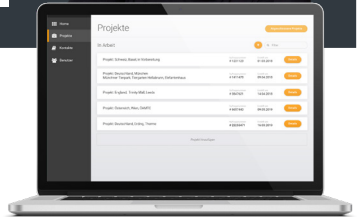

INNOTECH Arbeitsschutz GmbH

Laizing 10, A-4656 Kirchham

T: +43 7619 22122-0

office@innotech.at | www.innotech.at

